

**SWINOMISH INDIAN TRIBAL COMMUNITY
OFFICE OF PLANNING & COMMUNITY DEVELOPMENT**

11430 Moorage Way • La Conner, WA 98257
Phone 360-466-7280 FAX 360-466-1615

**SWINOMISH AND SKAGIT COUNTY
Residential Building, Mechanical and Plumbing Codes
Common Code References***

<u>Type of Construction</u>	<u>Applicable Code</u>
Bldg/Structural.....	2003 IRC
Mech. (electric/oil).....	2003 IRC
Mech & Gas Piping (natural gas).....	2003 IRC
Mech & Gas Piping (propane).....	2002 NFPA 54 & 58
Plumbing.....	2003 UPC
Energy & Ventilation.....	2003 WA ST VIAQ & WSEC

FOUNDATIONS AND SITE PREPARATION

1. **IRC R403.1.5** The top surface of **footings** must be level. Footings shall be stepped when necessary to change the top surface of a footing or where the bottom surface of a footing exceeds a 10% slope.
2. **IRC R403.1.3.2** For **slabs-on-grade** cast monolithically with a footing, one No.5 or two No. 4 bars must be located in the middle third of the footing depth.
3. **IRC R403.1.4.2** **Interior footings** supporting bearing or braced walls and cast monolithically with a slab on grade must extend to a depth of not less than 12 inches below the top of the slab.
4. **IRC R403.1 & Table R403.1** Minimum requirements for **foundations and footings**: Footings must be a minimum of 6 inches in thickness. When the required width of footings exceeds 17 inches, per table R403.1, the footing must be a minimum of 8 ½ inches in thickness.

**TABLE R403.1
MINIMUM WIDTH OF CONCRETE OR MASONRY FOOTINGS
(in inches)**

	LOAD-BEARING VALUE OF SOIL (psf)			
	1,500	2,000	3,000 (a)	≥ 4,000 (a)
Conventional light-frame construction				
1-story	12	12	12	12
2-story	15	12	12	12
3-story	23	17	12	12

(a) Must be verified by soils report from licensed geotechnical engineer.

* Code sections referenced in this document do not necessarily contain the entire code section or the exact wording. Tables shown have been abbreviated to show some, but not necessarily all, options. Additional code requirements and options are the responsibility of the individual.

5. **IRC R403.1.3** Where a construction joint is created between a footing and a stem wall, a minimum of one vertical No. 4 bar must be provided at not more than 4 feet on center. The **vertical bar** must extend to 3 inches clear of the bottom of the footing, have a **standard hook** and extend a minimum of 14 inches into the stem wall. Skagit County policy requires that these vertical bars be placed in the forms prior to the footing inspection and that concrete be cast with bars in place. Rebar with hooks may not be wet-set under Skagit County policy.
6. **IRC R403.1.3.1 Footings** with stem walls must be provided with a minimum of one horizontal No. 4 rebar in the footing.
7. **IRC R404.1.4 Plain concrete** foundation walls must comply with all of the following:
 - a. A minimum of one No. 4 bar must be located in the upper 12 inches of the wall.
 - b. Wall height must not exceed 8 feet.
 - c. Unbalanced backfill must not exceed 4 feet.
 - d. A minimum wall thickness of 7.5 inches is required, except that a minimum of 6 inches is permitted for walls not exceeding 4 feet 6 inches in height.
8. **IRC R404.1.3** An **engineered foundation design** is required when foundation walls are subject to hydrostatic pressure from groundwater or when supporting more than 48 inches of unbalanced backfill and do not have permanent lateral support at the top and bottom. Unbalanced backfill is the difference in height between the exterior and interior finish ground level. An example of permanent lateral support would be a slab at the bottom of the wall and a floor diaphragm at the top of the wall. An approved Skagit County alternate method, as an exception to an engineered foundation design, is shown below. In the diagram below, the full height concrete wall must be provided until the backfill on the outside of the wall is 4 feet or less in height. This detail does not allow use of a cripple or pony wall. Where floor joists are perpendicular to the wall, the requirement for the A35 (or equal) at 32" on center applies.

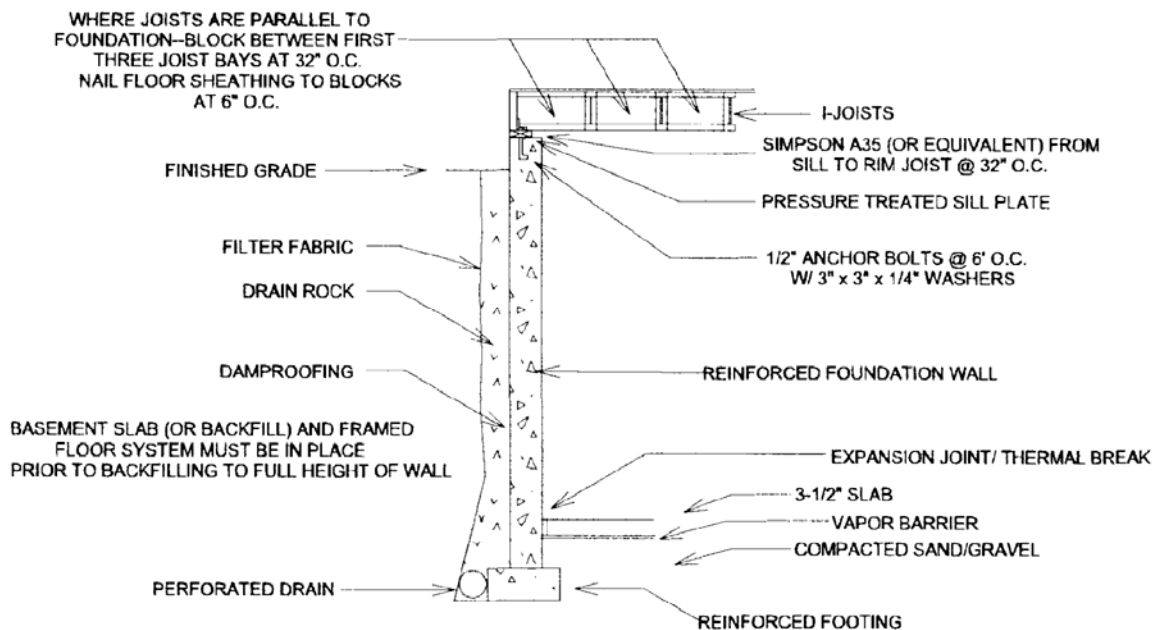

9. **IRC R404.1.4 Foundation** walls not complying with the requirements listed above for plain concrete, must comply with tables R404.1.1(2), R404.1.1(3), R404.1.1(4), or the table provided below for vertical reinforcement and must also have (2) No. 4 horizontal bars located in the upper 12 inches of the wall.

Minimum Wall Width	Maximum wall Height	Grade 60 Vertical Reinforcement	Grade 60 Vertical Reinforcement	Grade 40 Vertical Per Skagit County
8" (1)	6'	#4 @ 48" OC		#4 @ 30" OC
8" (1)	7'	#5 @ 48" OC	#4 @ 30" OC	#4 @ 18" OC
8" (1)	8'	#6 @ 48" OC	#4 @ 20" OC	#4 @ 14" OC
8" (1)	9'	#6 @ 32" OC	#4 @ 14" OC	#4 @ 10" OC

(1) Two horizontal #4 rebar are required in the upper 12" of the wall.

11. **IRC R405.1 Foundation drains** must be installed around foundations that retain earth and enclose habitable or usable space below grade. Tiles, pipes and other approved materials must discharge by gravity or mechanical means to an approved drainage system.
12. **IRC R408.2 Under-floor areas** must be **ventilated** by approved mechanical means or by openings in exterior perimeter wall (1 sq.ft. for each 150 sq.ft. of area). Openings must be located as close to corners as practical and arranged to provide cross ventilation on at least two opposite sides. Vents must be covered with 1/4" corrosion-resistant wire mesh.
13. **IRC R403.1.6.1 Foundation plates** must be bolted to foundation with not less than 1/2" steel bolts embedded 7" minimum into concrete and spaced not more than 6' apart. There must be at least two bolts per piece with one bolt located between 3 1/2" and 12" from each end of each piece.
14. **IRC R602.11.1 Steel plate washers** a minimum of **3" x 3" x 1/4"** must be used on each anchor bolt.
15. **IRC R602.10.6** Wall to foundation connections using **holdowns** must have the holdowns attached to or hooked around the reinforcing steel. All foundation wall **holdowns** must be installed at time of foundation inspection.
16. **IRC R406.1** Foundation walls enclosing **basements** below finished grade must be damp-proofed.
17. **IRC R506.1** The minimum thickness of concrete **slabs** supported on ground is 3 1/2".
18. **IRC R319.1** All **wood in contact with concrete**, masonry or earth must be pressure treated wood or foundation-grade cedar or redwood, and marked by an approved agency. Cut ends of treated posts must be re-treated or be provided with protection from contact with concrete.
19. **IRC R319.3** Fasteners for pressure treated and fire-retardant wood must be of hot-dipped galvanized steel, stainless steel or copper. *Exception:* 1/2-inch diameter or greater steel bolts.
20. **IRC R319.1 Wood joists** closer than 18" or wood girders closer than 12" to the ground, must be of treated wood or wood of natural resistance to decay.
21. **IRC R408.3 Under floor areas** must be provided with **access**. Access openings shall be 18"x 24" if access is through the floor, and 16"x 24" if access is through an exterior wall. If access is through an

exterior wall, a space 16 inches wide and 24 inches in depth must be provided in front of the opening. Through-wall openings must not be located under doors into the building.

22. **WSEC 502.1.6.7** Under floor areas must have a black plastic 6 mil **vapor barrier** lapped a minimum of 1' at each joint and extending up foundation a minimum of one foot.

FRAMING

23. **IRC R319.3** Fasteners for pressure treated and fire-retardant wood must be of hot-dipped galvanized steel, stainless steel or copper. *Exception:* 1/2-inch diameter or greater steel bolts.

IRC R319.1.4 Columns and posts located on concrete floors exposed to the weather, water splash or in basements must be supported by concrete piers or metal pedestals projecting above floors, unless approved wood of natural resistance to decay or treated wood is used. The pedestals must project at least 6" above exposed earth and at least 1" above such floors.

24. **IRC R319.1.4** Wood columns must be **restrained** to prevent lateral displacement at the bottom end.
25. **IRC R503.1.1** End joints in lumber used as **subflooring** must occur over supports unless end-matched lumber is used, in which case each piece must bear on at least two joists. Subflooring may be omitted when joist spacing does not exceed 16 inches and a 1-inch nominal tongue-and-groove wood strip flooring is applied perpendicular to the joists.

Fig. 14 • Post-Beam Connections

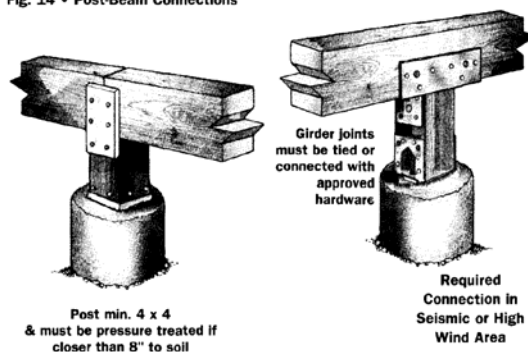

26. **IRC R319.1 #4** Wood members entering **concrete** walls must be provided with a 1/2" air space at top, sides and ends.
27. **IRC R602.9/602.10.2 Cripple walls** must be framed of studs not less in size than the studding above. When exceeding 4 feet in height, such walls must be framed of studs having the size required for an additional story. Cripple walls less than 14 inches high must be sheathed on at least one side and fastened to top and bottom plates or the cripple walls have solid blocking. Cripple walls must be braced with 15% more bracing than as required for the wall above, with wall panel spacing not more than 18'.
28. **IRC R502.7** Joists, rafters and trusses must be supported to prevent rotation by installing **solid blocking** at each bearing point or as required by manufacturer.
29. **IRC R502.4 Bearing partitions** perpendicular to joists must not be offset from support by more than the depth of the joists. At minimum, double joists are required under parallel bearing partitions. Joists

framed into sides of girders must be supported by joist hangers or ledger strips.

30. **IRC R502.8.1 Notches** on the ends of joists may not exceed one-fourth the joist depth. Notches in the top or bottom of joists may not exceed one-sixth the depth or be located in the middle third of the span. Holes bored in joists may not be within 2 inches of the top or bottom of the joist, and the diameter of any such hole may not exceed one-third the depth of the joist. Holes and notches must not be within 2" of each other.
31. **IRC R502.6** In floor construction, joists and beams must have not less the 1.5 inches of **bearing** on wood or metal and not less than 3 inches on concrete.
32. **IRC R602.7** In wall construction, beams and headers must have **bearing** on jack or trimmer studs as required by IRC Tables R502.5(1) and R502.5(2). In most cases 2 or 3 trimmer/jack studs are required.
33. **IRC R602.3.1 Table R602.3 (#5) Studs** in exterior walls and interior bearing walls of buildings must be not less than 2" x 4". The maximum laterally unsupported stud height in bearing walls is 10'.

**TABLE R602.3 (5)
SIZE, HEIGHT AND SPACING OF WOOD STUDS^a**

BEARING WALLS						NONBEARING WALLS	
Stud Size (inches)	Laterally unsupported stud height ^a (feet)	Maximum spacing when supporting roof and ceiling only (inches)	Maximum spacing when supporting one floor, roof and ceiling (inches)	Maximum spacing when supporting two floors, roof and ceiling (inches)	Maximum spacing when supporting one floor only (inches)	Laterally unsupported stud height ^a (feet)	Maximum spacing (inches)
2 x 3*	—	—	—	—	—	10	16
2 x 4	10	24	16	—	24	14	24
2 x 6	10	24	24	16	24	20	24

a. Listed heights are distances between points of lateral support placed perpendicular to the plane of the wall. Increases in unsupported height are permitted where justified by analysis.

* May not be used in exterior walls.

34. **IRC R802.10.2 Trusses** must be designed by a registered design professional, in accordance with ANSI/TPI1 standards.
35. **IRC R802.10.3 Trusses** must be **braced** to prevent lateral rotation and provide lateral stability in accordance with the individual truss design drawings.
36. **IRC R802.10.4 Truss** members must not be cut, notched, drilled, spliced or otherwise altered in any way without the approval of a registered design professional. **Alterations** resulting in the addition of loads that exceed the design load for the truss will not be permitted without verification that the truss is capable of supporting such additional loading.

37. **IRC R602.7** For prescriptive exterior wall **header sizes**, see table R502.5(1). Interior and exterior non-bearing walls do not require load-bearing headers.

Table R502.5(1)
Girder Spans^a and Header Spans^a for Exterior Bearing Walls
(Maximum spans for Douglas fir-larch, hem-fir, southern pine, and spruce-pine-fir^b and required number of jack studs)

Girders and Headers Supporting	Size	Ground Snow Load (psf)											
		30						50					
		Building width ^c (feet)											
		20		28		36		20		28		36	
Roof and ceiling	2-2x6	5-5	1	4-8	1	4-2	1	4-8	1	4-1	1	3-8	2
	2-2x8	6-10	1	5-11	2	5-4	2	5-11	2	5-2	2	4-7	2
	2-2x10	8-5	2	7-3	2	6-6	2	7-3	2	6-3	2	5-7	2
	2-2x12	9-9	2	8-5	2	7-6	2	8-5	2	7-3	2	6-6	2
	3-2x8	8-4	1	7-5	1	6-8	1	7-5	1	6-5	2	5-9	2
	3-2x10	10-6	1	9-1	2	8-2	2	9-1	2	7-10	2	7-0	2
Roof, ceiling and one center-bearing Floor	2-2x8	5-9	2	5-0	2	4-6	2	5-2	2	4-6	2	4-1	2
	2-2x10	7-0	2	6-2	2	5-6	2	6-4	2	5-6	2	5-0	2
	2-2x12	8-1	2	7-1	2	6-5	2	7-4	2	6-5	2	5-9	3
	3-2x8	7-2	1	6-3	2	5-8	2	6-5	2	5-8	2	5-1	2
	3-2x10	8-9	2	7-8	2	6-11	2	7-11	2	6-11	2	6-3	2
Roof, ceiling and one clear span floor	2-2x8	5-0	2	4-4	2	3-10	2	4-10	2	4-2	2	3-9	2
	2-2x10	6-1	2	5-3	2	4-8	2	5-11	2	5-1	2	4-7	3
	2-2x12	7-1	2	6-1	3	5-5	3	6-10	2	5-11	3	5-4	3
	3-2x8	6-3	2	5-5	2	4-10	2	6-1	2	5-3	2	4-8	2
	3-2x10	7-7	2	6-7	2	5-11	2	7-5	2	6-5	2	5-9	2

- a. Spans are given in feet and inches.
b. Tabulated values assume #2 grade lumber.
c. Building width is measured perpendicular to the ridge. For widths between those shown, spans are permitted to be interpolated.
d. NJ - Number of jack studs required to support each end. Where the number of required jack studs equals one, the header is permitted to be supported by an approved framing anchor attached to the full-height wall stud and to the header.

38. **IRC R602.3.2** Exterior wood stud walls must be capped with a double **top plate** installed to provide overlapping at corners and intersections with bearing partitions. End joints must be offset at least 24 inches. A single top plate may be installed provided the plate is tied at joints, corners and intersecting walls by a minimum 3x6 steel plate, nailed with six 8d nails on each side of joint.
39. **IRC R802.3.1 Rafters** not parallel to ceiling joists must be connected with 1 x 4 minimum cross ties at a maximum of 4'o.c.
40. **IRC R802.3 Ridge board:** Minimum 1" thickness. **Valley or hip rafter:** Minimum 2" thickness. Minimum depth not less than the cut end of the rafter.
41. **IRC R803.2.1.1** Plywood **roof sheathing**, if exposed on underside, must be exterior grade.

42. **IRC R905.7.1** When **spaced sheathing** is used, sheathing boards must not be less than 1" x 4" nominal dimension and must be spaced to coincide with the placement of fasteners. When 1" x 4" spaced sheathing is installed at 10" on center or more, additional 1" x 4" boards must be installed between the sheathing boards.
43. **IRC R806.2** Enclosed attic and rafter spaces must have cross **ventilation** for each separate space by vent openings protected against the entrance of rain and snow. The net free vent area may not be less than 1/150 of the space ventilated. *Exception:* The area may be 1/300, provided at least 50 percent and not more than 80 percent of the required vents are in the upper portion of the space and at least 3' above eave vents or if a vapor barrier with a one perm maximum rating is applied to the warm side of the ceiling. The openings must be covered with corrosion-resistant 1/4" screen.
44. **WSEC 502.1.4.4** An **insulation dam** must be provided at the attic access opening when using blown-in insulation.
45. **IRC R602.6** Any stud in an exterior wall or bearing partition may be **cut or notched** to a depth not exceeding 25 percent of its width. Studs in nonbearing partitions may be notched to a depth not to exceed 40 percent of a single stud width. Any stud may be bored or drilled, provided that the diameter of the resulting hole is no greater than 40 percent of the stud width, the edge of the hole is no closer than 5/8 inch to the edge of the stud, and the hole is not located in the same section as a cut or notch.

Exceptions:

1. A stud may be bored to a diameter not exceeding 60 percent of its width, provided that such studs located in exterior walls or bearing partitions are doubled and that not more than two successive studs are bored.
2. Approved stud shoes may be used when installed in accordance with the manufacturer's recommendation.

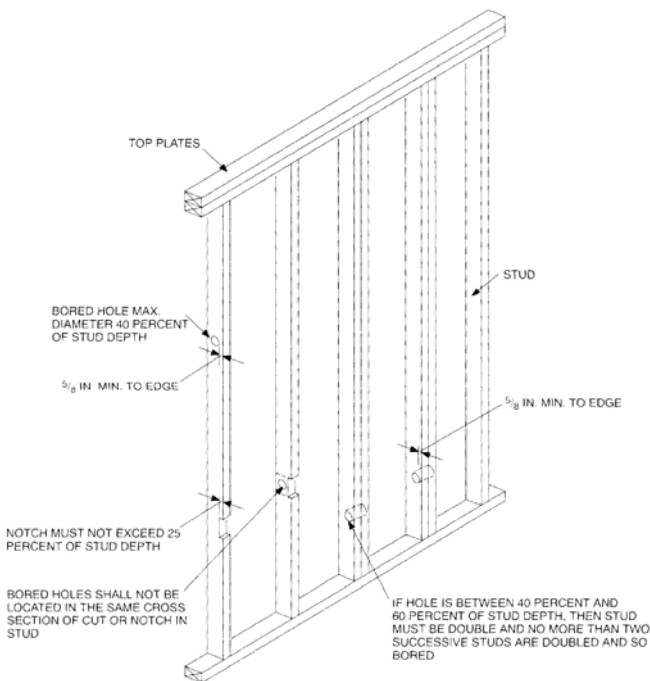

For SI: 1 inch = 25.4 mm.

Note: Condition for exterior and bearing walls.

FIGURE R602.6(1)
NOTCHING AND BORED HOLE LIMITATIONS FOR EXTERIOR WALLS AND BEARING WALLS

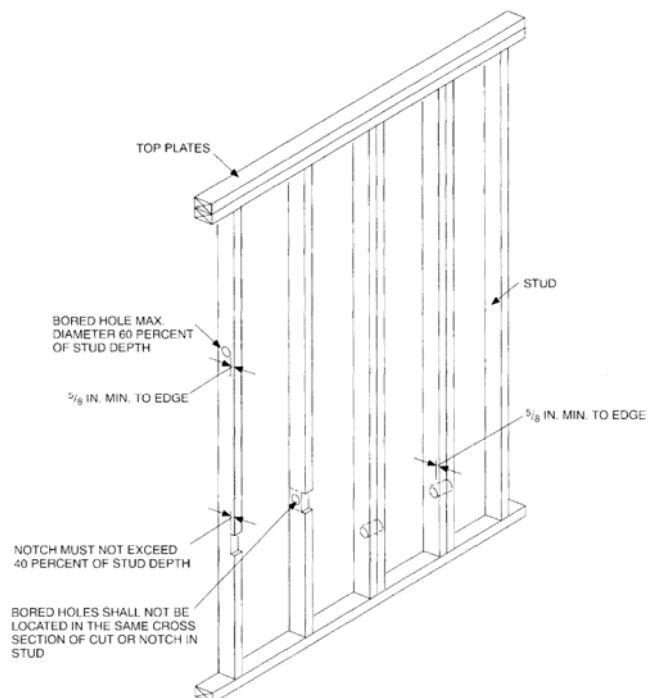

For SI: 1 inch = 25.4 mm.

FIGURE R602.6(2)
NOTCHING AND BORED HOLE LIMITATIONS FOR INTERIOR NONBEARING WALLS

46. **IRC R602.10.11** Exterior and interior **braced wall lines** are required for all buildings. Typically interior braced wall lines need to be braced at 25 feet on center, other options may exist. Interior braced wall lines may be located at 35 feet on center to accommodate one 900 sq. ft. room. When any wall line of the building is over 50 feet long, the interior braced wall must have a continuous footing and foundation or a braced (sheathed) cripple wall below. Exterior braced wall lines must have a braced wall panel at each end. Braced wall panels that do not begin at the building corner are allowed to begin within 8 feet from the corner if one 1800 lb. capacity holddown is provided at the end of the panel closest to the corner, or if a 2-foot braced wall panel is provided at both sides of the corner.
47. **IRC R602.10 & IRC R602.10.4** **Braced wall panel construction methods.** The construction of braced wall panels may be in accordance with one of the following methods (other methods exist but are less commonly used):
1. Wood structural panel sheathing with a thickness not less than 5/16 inch for 16-inch stud spacing and not less than 3/8 inch for 24-inch stud spacing. Each braced wall panel shall be at least 48 inches in length.
 2. Gypsum board with minimum 1/2 inch thickness and fastened at 7 inches on center. Each braced wall panel shall be at least 96 inches in length where applied to one face of a braced wall panel and at least 48 inches where applied to both faces.
48. **IRC R602.10.6** **Alternate braced wall panels.** Alternate braced wall lines constructed in accordance with one of the following provisions shall be permitted to replace each 4 feet of braced wall panel:
1. In one-story buildings, each panel must have a length of not less than 2 feet, 8 inches and a height of not more than 10 feet. Each panel must be sheathed on one face with 3/8 inch-minimum-thickness wood structural panel sheathing nailed with 8d common or galvanized box nails, and blocked at all wood structural panel sheathing edges. Two anchor bolts minimum must be provided in each panel. Anchor bolts must be placed at panel quarter points. Each panel end stud must have a tie-down device fastened to the foundation, capable of providing an uplift capacity of at least 1,800 pounds. The tie-down device must be installed in accordance with the manufacturer's recommendations. The panels must be supported directly on a foundation or on floor framing supported directly on a foundation which is continuous across the entire length of the braced wall line. This foundation must be reinforced with not less than one No. 4 bar top and bottom. When the continuous foundation is required to have a depth greater than 12 inches, a minimum 12-inch-by-12-inch continuous footing or turned down slab edge is permitted at door openings in the braced wall line. This continuous footing or turned down slab edge must be reinforced with not less than one No. 4 bar top and bottom. This reinforcement must be lapped 15 inches with the reinforcement required in the continuous foundation located directly under the braced wall line.
 2. In the first story of two-story buildings, each braced wall panel must be in accordance with Item 1 above, except that the wood structural panel sheathing must be provided on both faces, sheathing edge nailing spacing must not exceed four inches on center, at least three anchor bolts must be placed at one-fifth points, and tie-down device uplift capacity must not be less than 3,000 pounds.

49. **IRC R602.8 Fire Blocking** shall be provided to cut off concealed draft openings (both vertical and horizontal) and to form an effective fire barrier between stories, and between a top story and the roof space.

50. **IRC R602.8 Install fire blocking at:**

1. In concealed spaces of stud walls and partitions, including furred spaces and parallel row of studs or staggered studs; as follows:
 - A. Vertically at the ceiling and floor levels.
 - B. Horizontally at intervals not exceeding 10 feet.
2. At all interconnections between concealed vertical and horizontal spaces such as occur at soffits, drop ceilings and cove ceilings.
3. In concealed spaces between stair stringers at the top and bottom of the run
4. At openings around vents, pipes, and ducts at ceiling and floor level, with an approved material to resist the free passage of flame and products of combustion.
5. For site-built chimneys and fireplaces, fire blocking must be a minimum of 1" thick and supported on metal strips or metal lath.
6. Fire blocking of cornices of a two-family dwelling is required at the line of dwelling unit separation.

Fig. 40
Air Flow Through Soffit

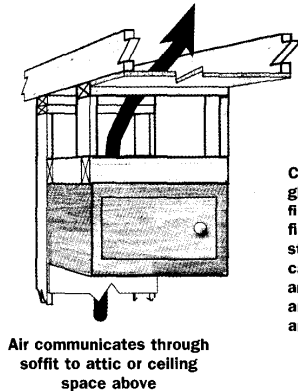

Fig. 41
Soffit Fireblocking Options

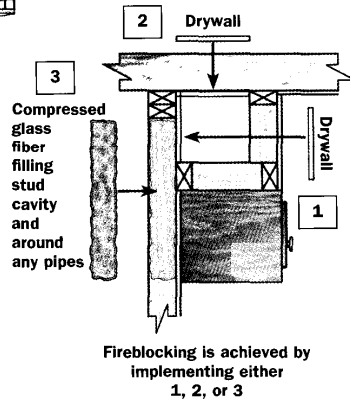

Fig. 42
Coved or Dropped Ceiling

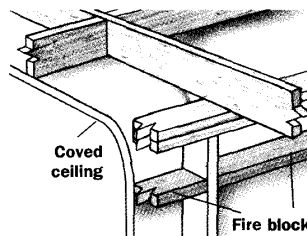
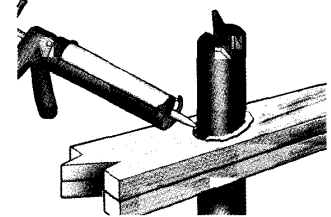

Fig. 43
Fireblock Openings around Pipes



ROOF COVERINGS

51. **IRC R905.2 Asphalt shingles** require underlayment (15lb felt paper or equivalent) and a minimum 4:12 pitch on solid sheathed decks. Asphalt shingles may be installed on slopes as low as 2:12, if provided double underlayment. Asphalt shingles shall be self sealing or be interlocking.
52. **IRC R905.8.2 / R905.8.6 Wood shakes** require underlayment. Wood shake weather exposure shall be installed per Table R905.8.6.

**Table R905.8.6
Wood Shake Weather Exposure and Roof Slope**

Roofing Material	Length (inches)	Grade	Exposure (inches)
			4:12 pitch or steeper
Shakes of naturally	18	No. 1	7-1/2"

durable wood	24	No. 1	10 ^a
Taper-sawn shakes of Naturally durable wood	18	No. 1	7-1/2"
	24	No. 1	10
	18	No. 2	5-1/2"
	24	No. 2	7-1/2"

53. **IRC R905.8.8** Roof **valley flashing** must not be less than No. 26 gage corrosion-resistant sheet metal and shall extend 11 inches from the center line each way.

EXTERIOR WALLS

54. **IRC R703.7** **Anchored stone and masonry veneer** must be supported on a noncombustible foundation. The maximum nominal thickness of 4" is required for exterior masonry. The maximum height above a noncombustible foundation is 20 feet with an additional 8 feet permitted for gabled ends.
55. **IRC R703.7.4** **Veneer ties** must be No. 9 U.S. gage wire or sheet metal ties N. 22 U.S. gage by 7/8" corrugated. Each tie must not support more than 2 square feet of wall area. Metal ties are required around openings greater than 16" in either dimension. Metal ties around the perimeter of openings shall be spaced not more than 3' on center and placed within 12" of the wall opening.
56. **IRC R703.7.4.2** A minimum of 1" of **air space** is required between veneer and sheathing but not more than 4-1/2". *Exception: If airspace is maintained, weather-resistant membrane or asphalt-saturated felt underlayment is not required over water-repellant sheathing materials.*
57. **IRC R703.7.6** **Weepholes** must not be less than 3/16" in diameter spaced 33" on center.
58. **IRC R703.2** Exterior wall shall be covered with asphalt-saturated felt with a minimum weight of 14 pounds or other approved **weather-resistant** material.

STAIRWAYS

59. **IRC R311.5** A minimum **stairway width** of 36" is required above the handrail height. A clear width of 31-1/2" is allowed below the handrail where a handrail is installed on one side and 27" where two handrails are installed. A 6'8" minimum **head height** is required in all parts of the stairway. The maximum **riser height** is 7-3/4". The greatest riser height within any flight of stairs shall not exceed the smallest by more than 3/8".
60. **IRC R311.5.3.2** The minimum **tread depth** is 10". Open risers are permitted provided that the opening between the treads does not permit the passage of a 4" diameter sphere.

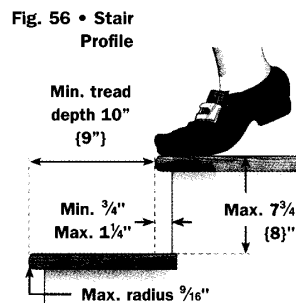

61. **IRC R311.5.4** There must be a **floor** or **landing** at the top and bottom of each stairway. *Exception:* A floor or landing is not required at the top of an interior flight of stairs, provided a door does not swing over the stairs. The width of each landing shall not be less than the stairway served. Every landing shall have a minimum dimension of 36" measured in the direction of travel.

62. **IRC R311.5.6.1 Handrails** must be provided on at least one side of each continuous run of treads or flight with four or more risers. **Handrail height**, measured vertically from the tread nosing, may not be less than 34" and not more than 38". Handrails must be **continuous** for the full flight of stairs from the top riser to the lowest riser. Handrail ends must be returned or must terminate in newel posts or safety terminals. Handrails adjacent to a wall shall have a minimum distance of 1-1/2" between the wall and handrail.

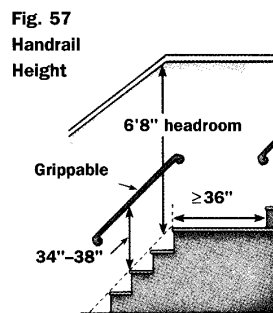

63. **IRC R311.5.6.3** Handrails with a circular cross section must have an outside diameter of at least 1-1/4" and not greater than 2".

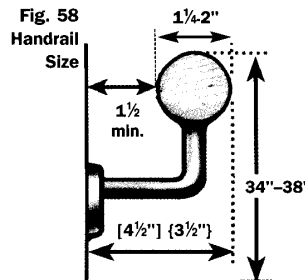

64. **IRC R312.2** Porches, balconies, or raised floor spaces located more than 30" above the floor or grade must have **guards** not less than 36" in height. Open sides of stairs with a total rise of more than 30" above the floor or grade must have guards not less than 34" in height measured vertically from the nosing of the treads. Intermediate rails or ornamental closures must not allow the passage of a 4" sphere or more in diameter. The triangular opening formed by the riser, tread, and bottom rail of a guard at the open side can have a space where a 6" sphere cannot pass through.

65. **IRC R311.2.2** Enclosed accessible **space under stairs** must have walls, under stair surface, and any soffits protected on the enclosed side with 1/2" gypsum board.

66. **IRC R311.2.1** Required exterior exit balconies, stairs, and similar exit facilities shall be positively anchored to the primary structure to resist both vertical and lateral forces. Such attachment shall not be accomplished by use of toenails or nails subject to withdrawal.

67. **IRC R311.5.8** Circular stairways, spiral stairways, and winders must conform with all requirements for standard stairs except as specified below in # 68, 69.
68. **IRC R311.5** **Circular stairways** must have a minimum tread depth not less than 10", and the smaller radius cannot be not less than twice the width of the stairway.
69. **IRC R311.5.8.1** **Spiral stairways** are permitted, provided the minimum width must be 26" with each tread having 7-1/2" minimum tread depth at 12" from the narrower edge. All treads must be identical, and the rise no more than 9-1/2". A minimum headroom of 6 feet 6 inches is required.

TEMPERED GLASS (GLAZING)

70. **IRC R308.4** The following shall be considered specific **hazardous locations** for the purposes of glazing:
1. Glazing in doors.
 2. Glazing in doors and enclosures for hot tubs, whirlpools, saunas, steam rooms, bathtubs, and showers. Glazing in any part of a building wall enclosing these compartments where the bottom exposed edge of the glazing is less than 60 inches measured vertically above any standing or walking surface.
 3. Glazing, adjacent to a door where the nearest vertical edge is within a 24-inch arc of the door in a closed position and whose bottom edge is less than 60 inches above the floor or walking surface.
 4. Glazing that meets all of the following conditions:
 - 7.1. Exposed area of an individual pane greater than 9 square feet.
 - 7.2. Bottom edge less than 18 inches above the floor.
 - 7.3. Top edge greater than 36 inches above the floor.
 - 7.4. One or more walking surfaces within 36 inches horizontally of the glazing.
 5. All glazing in railings.
 6. Glazing in walls and fences enclosing indoor and outdoor swimming pools, hot tubs and spas where the bottom edge of the glazing is less than 60 inches above a walking surface and within 60 inches horizontally of the water's edge.
 7. Glazing adjacent to stairways, landings and ramps when the exposed surface of the glass is less than 60 inches above the place of the adjacent walking surface.
 8. Glazing adjacent to stairways within 60 inches of the bottom tread of a stairway when the exposed surface of the glass is less than 60 inches above the nose of the tread.
71. **IRC 308.1** Each pane of glazing installed in hazardous locations shall be provided with a manufacturer's or installer's label, designating the type and thickness of glass and the safety glazing standard with which it complies, which is visible in the final installation.

SKYLIGHTS

72. **IRC 308.6.2** The following types of glazing may be used:
1. Laminated glass with a minimum 0.015-inch polyvinyl butyral interlayer for glass panes 16 square feet or less in area located such that the highest point of the glass is not more than 12 feet above a walking surface or other accessible area; for higher or larger sizes, the minimum interlayer thickness shall be 0.030-inch.
 2. Fully tempered glass.
 3. Heat-strengthened glass.
 4. Wired glass.
 5. Approved rigid plastics.

PLUMBING

73. **UPC 103.5.1.3** No **plumbing** or drainage system or building sewer may be covered, concealed or put into use until it has been tested, **inspected** and approved.
74. **UPC 609.4** Plumbing **supply** piping must be **tested** with working water pressure or, except plastic piping, 50 p.s.i. air pressure.
75. **UPC 712.2,3** Plumbing **drains** must be **tested** with water filled to highest vent in system or 5 p.s.i. air pressure.
76. **UPC 313.1** All **piping** passing under or **through walls** must be protected from breakage. Approved provisions must be made for expansion of hot water piping. Voids around piping passing through concrete floors on the ground must be appropriately sealed.
77. **UPC 313.10.1** **Sleeves** shall be provided to protect all piping through concrete and masonry walls.
78. **UPC 314.5 / 314.5.1** **Horizontal piping** must be supported at sufficiently close intervals to prevent sagging. Pipe supports for ABS may not exceed 4 feet on center.
79. **UPC 416.0** Where two separate handles control the **hot and cold water**, the left-hand control must control the hot water. Single-handle mixing valves shall have the flow of hot water correspond to the markings on the fitting.
80. **UPC 415.1** **Whirlpool bathtubs** must provide a removable panel of sufficient dimension to access the pump.
81. **UPC 807.4** No domestic **dishwashing machine** may be directly connected to a drainage system or food waste disposer without the use of an approved dishwasher air-gap fitting on the discharge side of the dishwashing machine. Listed air gaps must be installed with the flood level (FL) marking at or above the flood level of the sink or drain board, whichever is higher.
82. **UPC 1007.0** **Floor drains** subject to infrequent use must be provided with a trap seal primer.
83. **UPC 412.4** **Floor slope.** Floors shall be sloped to floor drains where drainage occurs on a regular or frequent basis.
84. **UPC 609.2** All water service **yard piping** shall be at least twelve (12) inches below grade. Water pipes may not be run or laid in the same trench as the building sewer or drainage unless both of the following conditions are met:
- A. The bottom of the water pipe, at all points, shall be at least twelve (12) inches above the top of the sewer line.
 - B. The water pipe shall be placed on a solid shelf excavated at one side of the common trench with a minimum horizontal distance of 12" from the sewer or drain.
- Exception:** Piping constructed of materials which is approved for use within a building does not have a separation requirement.
85. **UPC 608.5** **Relief valves** must be provided with a drain, not smaller than the relief valve outlet, extending to the outside of the building and discharging downward 6"-24" above grade.
86. **UPC 603.4.7** **Hose bibs** must be protected by an approved non-removable type backflow prevention device.

87. **UPC 508.2 Water heaters** must be anchored or **strapped** in the upper and lower third of tank to resist horizontal displacement due to earthquake motion. A distance of 4" must be provided between the lower strap and the controls.
88. **UPC 508.4** When a water heater is located where water damage may occur from a leaking water heater, a **watertight pan** must be installed beneath with a minimum 3/4" drain to outside of building.
89. **UPC 408.2** All **plumbing fixtures**, including toilets, must be **caulked** or sealed at their base.
90. **UPC 508.5 Relief valve** piping may not discharge into a water heater pan.

MECHANICAL

91. **IRC R111.1 / NFPA54 7.1.1.1** No **mechanical** system or equipment regulated by this code may be connected to fuel source until approved by the building official.
92. **IRC G2417.4.1 / NFPA54 Gas piping** must be tested at a minimum pressure of 3 p.s.i. Gauges used for testing must have an upper range of not more than 5 times the test pressure.
93. **IRC M1307.3 / NFPA54 8.1.10.1** Gas appliances generating a glow, spark or flame capable of igniting flammable vapors may be installed in a **garage**, provided the pilots, burners, heating elements and switches are elevated at least 18" above the floor.
94. **IRC M1307.3.1 / NFPA54 8.1.10.2** All gas appliances installed in areas where they may be subjected to **mechanical damage** shall be suitably guarded against such damage by being installed behind adequate barriers or by being elevated or located out of the normal path of vehicles.
95. **IRC G2406.2 / NFPA54 9.1.2** No **gas appliance** may be installed in any **bedroom**, bathroom, closet or other enclosed area opening into such space. *Exception:* Direct vent appliances.
96. **IRC M 1305 / NFPA54 8.2.1** Equipment must be provided with sufficient **access** to allow inspection, maintenance and replacement without removing permanent construction. Heating system air filters, fuel-control valves, vent collars, air-handling units and externally mounted controls must be accessible for maintenance, repair and replacement.
97. **IRC R1804.2.6 / NFPA5410.6.2** Gas appliance **vent terminations** must meet the following:
1. The vent terminal must be located not less than 3 feet above a forced air inlet located within 10 feet.
 2. The vent terminal must be located not less than 4 feet below, 4 feet horizontally from, or 1 foot above any door, window, or gravity air inlet into a dwelling.
 3. The vent termination point must not be located closer than 3 feet to an interior corner formed by two walls perpendicular to each other.
 4. The bottom of the vent terminal must be located at least 12 inches above finished ground level.
 5. The vent termination must not be mounted directly above or within 3 feet horizontally from an oil tank vent or gas meter.
 6. Power exhauster terminations must be located not less than 10 feet from lot lines and adjacent buildings.
 7. The discharge must be directed away from the building.

98. **IMC 309.1-4** Condensate drainage must be discharged to an approved plumbing fixture, disposal area or to exterior of the building. Piping must be provided with means of preventing freezing in unheated spaces.
99. **IRC G2407.5, .6 / NFPA54 8.3.2, .3** Natural gas and propane appliances must be provided a sufficient supply of combustion air as follows:
- A. Interior spaces may be used to provide air if there is a minimum of 50 cubic feet per 1,000 B.T.U. and there are no exhaust fans, dryers, kitchen ventilation systems or fireplaces.
 - B. Two openings communicating with outside air, one within 12" of the ceiling and one within 12" of the floor. If the openings are horizontal, each must be 1 square inch per 2,000 B.T.U. If the openings are vertical, each must be 1 square inch per 4,000 B.T.U.
 - C. One opening communicating with outside air, within 12" of the ceiling. Horizontal or vertical opening must be 1 square inch per 3,000 B.T.U.
100. **IRC M1702, 1703** Pellet and oil appliances must be provided a sufficient supply of **combustion air** as follows:
Two openings communicating with outside air, one within 12" of the ceiling and one within 12" of the floor. If the openings are in a wall, each must be 1 square inch per 2,000 B.T.U. If the openings are in the floor and ceiling, each must be 1 square inch per 4,000 B.T.U.
101. **IRC M1501.1 & M1501.3** Clothes **dryer ducts** must be of smooth metal and terminate outside the building. Screens shall not be installed at the duct termination. Ducts may not be connected or installed with sheet metal screws. Maximum duct length is 25 feet. The maximum length must be reduced 2-1/2 feet for each 45 degree bend and 5 feet for each 90 degree bend.
102. **WA ST VIAQ 302.2.1 / IRC M1506** Bathrooms, laundry rooms, kitchens and similar rooms must be vented by an **exhaust fan**. Duct must terminate outside the building and be not less than 3 feet from any opening into the building. Ducts in an unheated space must be insulated to R-4 minimum.
103. **IRC M1801.3.4** Chimneys and vents must have airspace **clearance** to combustibles in accordance with the IRC and the chimney or vent manufacturer's installation instructions.
104. **IRC M1506.3** Kitchen **exhaust** fans must be 100 CFM minimum. Bathroom exhaust fans must be 50 CFM minimum.

DWELLING

105. **IRC R313** When work is performed that requires a permit, or when sleeping rooms are created, the entire building must be provided with smoke alarms. A smoke alarm must be installed in each sleeping room and outside the sleeping room in the immediate vicinity. There must be at least one smoke alarm on every floor level. All smoke alarms must be **hardwired** and **interconnected**. *Exception:* Smoke alarms are not required to be interconnected if the work performed does not result in the removal of interior wall finishes and

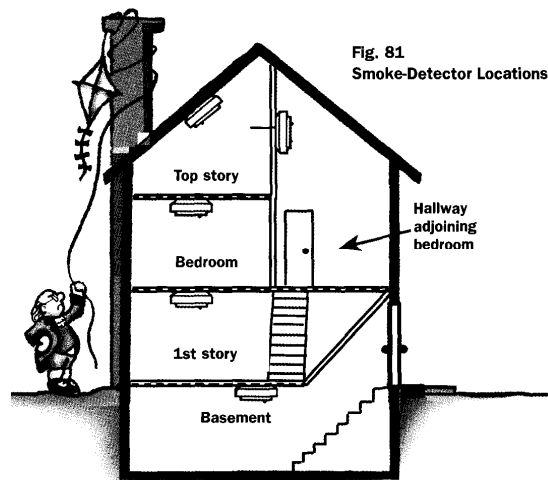

there is not an attic or crawl space which could provide access for hard wiring.

106. **IRC R807.1 Attic access** must have minimum size of 22" x 30" with 30" unobstructed headroom and be readily accessible
107. **IRC R304.3** All rooms must have a minimum **ceiling height** of seven (7) feet.
108. **IRC R304.1 / 304.2** Minimum habitable **room size** is 70 square feet with a minimum dimension of 7 feet. Every dwelling must have at least one room with minimum 120 square feet.
109. **IRC R310.1.1 / 1.2 / 1.3** Every **sleeping room** must have at least one operable **window** or exterior door approved for emergency egress or rescue. Windows must have a minimum opening area of 5.7 square feet (5 square feet if on the ground level), minimum net clear opening height of 24" and a minimum net clear opening width of 20". Finished sill height may not be more than 44" above the floor.

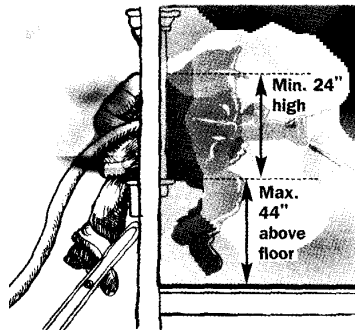

110. **IRC R307.2 Showers** must have a nonabsorbent wall covering extending to 72" above drain inlet with water-resistant backing.
111. **IRC R309.2** A **garage** must be separated from a residence and attic space with not less than 1/2" drywall of the garage side. If there is residential space above the garage, the ceiling must have 5/8" type-x drywall and all supporting walls must have 1/2" drywall.
112. **IRC R309.1** Any **door** between a garage and a residence must be either a 1-3/8" wood or metal door, or a 20-minute rated door.
113. **IRC R309.3** The **floor surface** in a garage must be non-combustible and sloped toward the garage door.
114. **IRC R321.1** Every dwelling must have its **address** plainly legible and visible from the street.
115. **IRC R311.4.3 / R311.5.4** There must be a **landing** on each side of a doorway. The minimum

required size is the width of the doorway and 36" in the direction of travel. The landing must be within 1-1/2" of the threshold level. *Exception:* Where a stairway of two or fewer risers is located on the exterior side of the door, other than the required exit door, a landing is not required for the exterior side of the door.

116. **WSVIAQ/ WSEC**

PART 1

Whole-House Ventilation: select **one** of the following methods.

- A. Fresh air will be circulated by the central forced air furnace along with a whole house exhaust fan. A single whole-house exhaust fan, which usually does double duty as a room spot fan, is required and must be controlled by a timer set to operate fan a minimum of 8 hours per day. The CFM capacity of the fan must be measured at 0.25 w.g. and have a maximum sone (noise) rating of 1.5. Fresh air intake ports or ducts are not required with this option. (WA VIAQ 303.4.1)

The minimum size of the fan is based on the number of bedrooms and the size of the house. For houses up to 3,000 square feet, the following sizes are acceptable:

- _____ 1 or 2 bedrooms - 75 CFM
- _____ 3 bedrooms - 90 CFM
- _____ 4 bedrooms - 105 CFM

For other options contact the Planning & Permit Center.

- B. Fresh air will be circulated by the central forced air furnace system. The furnace must have a fresh air intake duct and the blower must be activated by a timer to circulate air daily. An exhaust fan is not required with this system. (WA VIAQ 303.4.2)
- C. Fresh air will be supplied by wall or window vent ports in each bedroom, kitchen, living room and other habitable rooms along with a whole-house exhaust fan as described in option A. (WA VIAQ 303.4.1)
- D. A heat-recovery ventilation system. (WA VIAQ 303.4.4)

PART 2

Insulation and Windows: select **one** of the following methods. (WSEC Table 6-1)

	<u>Glazing %</u>	<u>U-factor</u>	<u>Ceiling</u>	<u>Vaulted</u>	<u>Walls</u>	<u>Floor</u>	<u>Slab</u>
1. (2x4 const.)	up to 12%	0.35	R-38	R-30	R-15	R-30	R-10

If you intend to use 2x4 construction, compute the window **glazing percentage of heated floor area** to verify that the project falls below the 12% maximum allowed glazing:

Total area of windows, skylights and patio doors: _____ sq. ft.
 Total heated area: _____ sq. ft.
 Total window area divided by total heated area = **glazing** _____ %.

DECKS

- 117. **IRC Table R301.5** Decks and stairs must be **designed** for 40# live load and 10# dead load and braced to resist lateral movement. See table R301.5.
- 118. **IRC Table R301.5 Guards** must be installed when deck is 30" or more above grade. Guards must be a minimum of 36" in height and able to withstand loads as specified in Table R301.5. Open guards must have intermediate rails or an ornamental pattern such that a sphere 4 inches in diameter cannot pass through.

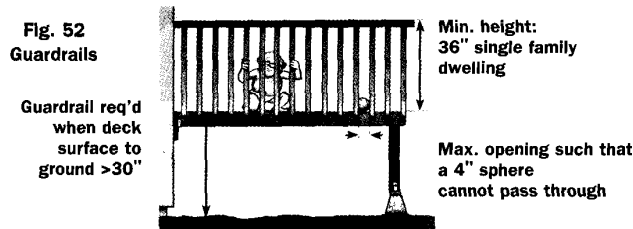

**TABLE R301.5
 MINIMUM UNIFORMLY DISTRIBUTED LIVE LOADS
 (in pounds per square foot)**

USE	LIVE LOAD
Decks (c)	40
Guardrails and handrails (b)	200
Guardrails in-fill components (d)	200
Stairs	40 (a)

- a. Individual stair treads shall be designed for the uniformly distributed live load or a 300-pound concentrated load acting over an area of 4 square inches, whichever produces the greater stresses.
- b. A single concentrated load applied in any direction at any point along the top.
- c. See Section R502.2.1 for decks attached to exterior walls.
- d. Guard in-fill components (all those except the handrail), balusters and panel fillers shall be designed to withstand a horizontally applied normal load of 50 pounds on an area equal to 1

square foot. This load need not be assumed to act concurrently with any other live load requirement.

119. **IRC R319** Structural exterior posts, girders, joists and decking to be **cedar or treated** material.
120. **IRC R502.2.1** A **deck ledger** must be adequately secured to the rim joist/framing using lag bolts or screws. See Skagit County Handout: *Deck Ledger Board Fastener Schedule* for more information.

Table R502.3.1(2)
Floor Joist Spans
 (This table abbreviated from the original)

		Dead Load = 10 psf			
		2 x 6	2 x 8	2 x 10	2 x 12
Joist Spacing (inches)	Specie and Grade	(ft. - in.)	(ft. - in.)	(ft. - in.)	(ft. - in.)
12	Douglas fir-larch #1	10 - 11	14 - 5	18 - 5	22 - 0
	Douglas fir-larch #2	10 - 9	14 - 2	17 - 9	20 - 7
	Hem-fir #1	10 - 6	13 - 10	17 - 8	21 - 6
	Hem-fir #2	10 - 0	13 - 2	16 - 10	20 - 4
16	Douglas fir-larch #1	9 - 11	13 - 1	16 - 5	19 - 1
	Douglas fir-larch #2	9 - 9	12 - 7	15 - 5	17 - 10
	Hem-fir #1	9 - 6	12 - 7	16 - 0	18 - 7
	Hem-fir #2	9 - 1	12 - 0	15 - 2	17 - 7
19.2	Douglas fir-larch #1	9 - 4	12 - 4	15 - 0	17 - 5
	Douglas fir-larch #2	9 - 1	11 - 6	14 - 1	16 - 3
	Hem-fir #1	9 - 0	11 - 10	14 - 8	17 - 0
	Hem-fir #2	8 - 7	11 - 3	13 - 10	16 - 1
24	Douglas fir-larch #1	8 - 8	11 - 0	13 - 5	15 - 7
	Douglas fir-larch #2	8 - 1	10 - 3	12 - 7	14 - 7
	Hem-fir #1	8 - 4	10 - 9	13 - 1	15 - 2
	Hem-fir #2	7 - 11	10 - 2	12 - 5	14 - 4

Table R502.3.3(1)
Cantilever Spans for Floor Joists Supporting Light-Frame Exterior Bearing Wall and Roof Only^{b, c, g}
 (This table abbreviated from the original)

Member & Spacing	Maximum Cantilever Span ^d								
	Ground Snow Load								
	≤ 20 psf			30 psf			50 psf		
	Roof Width			Roof Width			Roof Width		
	24 ft.	32 ft.	40 ft.	24 ft.	32 ft.	40 ft.	24 ft.	32 ft.	40 ft.
2 x 10 @ 16"	29"	21"	16"	26"	18"				
2 x 10 @ 12"	36"	26"	20"	34"	22"	16"	26"		
2 x 12 @ 16"		32"	25"	36"	29"	21"	29"	20"	
2 x 12 @ 12"		42"	31"		37"	27"	36"	27"	17"

- b. Spans are based on No. 2 Grade lumber of Douglas fir-larch or hem-fir, for repetitive (3 or more) members.
- c. Ratio of backspan to cantilever span shall be at least 3:1.
- d. Connections capable of resisting the indicated uplift force shall be provided at the backspan support.
- g. A full-depth rim joist shall be provided at the cantilevered end of the joists. Solid blocking shall be provided at the cantilever support.

Table 502.3.3(2)
Cantilever Spans for Floor Joists Supporting Exterior Balcony ^{a, b, e}

Member Size	Spacing	Maximum Cantilever Span (Uplift Force at Backspan Support in Lbs.) ^c	
		Ground Snow Load	
		≤30 psf	50 psf
2 x 10	12"	61"	57"
2 x 10	16"	53"	49"
2 x 10	24"	43"	40"
2 x 12	16"	72"	67"
2 x 12	24"	58"	54"

- a. Spans are based on No. 2 Grade lumber of Douglas fir-larch, hem-fir, for repetitive (3 or more) members.
- b. Ratio of backspan to cantilever span shall be at least 2:1.
- c. Connections capable of resisting the indicated uplift force shall be provided at the backspan support.
- e. A full-depth rim joist shall be provided at the cantilevered end of the joists. Solid blocking shall be provided at the cantilevered support.